



**Directions (1-5):** Study the following information carefully and answer the questions given below.

Eight people I, J, K, L, M, N, O, and P are going to a hospital for COVID-19 testing in different months January, February, March, April, May, June, July, and September but not necessarily in the same order.

M goes in the month having less than 31 days, but not in February. P goes two persons after M. Two persons are going to the hospital between P and N. As many persons go before N is one more than the persons who go after N. Only one person goes between J and O, who doesn't go on the month having less than 31 days. L goes two months before I but doesn't go before J.

**1) Who among the following goes in January?**

- A. The person who goes immediately before L
- B. I
- C. The person who goes two months before N
- D. J
- E. Both A & D

**2) Four of the following five are alike in a certain way and thus form a group as per the given arrangement. Which of the following does not belong to that group?**

- A. J
- B. O
- C. N
- D. M
- E. K

**3) How many persons are going to the hospital between O and K?**

- A. One
- B. Two
- C. Three
- D. Four
- E. No one

**4) Who goes to a hospital in July?**

- A. M
- B. N
- C. K
- D. I
- E. P

**5) If P is related to J and M is related to O, then who among the following person is related to I?**

- A. The person who goes on April
- B. The person who goes on May
- C. The person who goes on September
- D. K
- E. None of these

**Direction (6-10):** Answer the questions based on the information given below.

Ten persons viz. A, B, C, D, E, F, G, H, I and J are standing in two parallel rows such that the persons in both the rows faces each other, but not necessarily in the same order. The persons in row 1 faces south and the persons in row 2 faces north.



## Top 50 Puzzle and Seating for IBPS RRB PO Pre 2021 (Based on 01<sup>st</sup> Aug 2021 Exam)

G, who doesn't stand at the ends, stands third to the left of the one who faces C. J stands second to the right of C. Only one person stands between A and G who faces B. The number of persons stand to the right of B is the same as the number of persons stand to the left of F. H stands fourth to the right of I who doesn't face D. E doesn't face north.

6) Who among the following stands facing J?

- A.E
- B.D
- C.G
- D.A
- E. None of these

7) Four of the following five are alike in a certain way and hence form a group. Find the one that doesn't belong to that group.

- A.IB
- B.AC
- C.DF
- D.ED
- E.GJ

8) If A is related to B and J is related to H in a certain way, then who among the following person is related to F?

- A.I
- B.E
- C.D
- D.C
- E. None

9) What is the position of E with respect to J?

- A. Exactly opposite
- B. Second to the left
- C. Second to the right
- D. Third to the left
- E. Third to the right

10) Who among the following person stands opposite to the one who stands third to the right of F?

- A. person who stands left end in row2
- B.G
- C. person who stands immediate left of J
- D.A
- E.H

**Direction (11-15): Study the following information carefully and answer the questions given below.**

Eight people P, Q, R, S, T, U, V, and W are sitting around a circular table and all are facing towards the centre. All of them are using different mobile brands Oppo, Apple, Vivo, and Sony not more than two persons using the same mobile brands. All the information is not necessarily in the same order.

The person who uses Vivo is sitting second to the right of W, both of them using the same mobile brand. Two persons sit between W and the person who uses Oppo. Q uses Sony and sits opposite to W. Three persons sit between the persons who are using apple. One of the persons who uses apple has both the immediate neighbors are using Vivo. U sits third



## Top 50 Puzzle and Seating for IBPS RRB PO Pre 2021 (Based on 01<sup>st</sup> Aug 2021 Exam)

to the left of R and using Oppo. V is not facing the person who uses Oppo and Apple. P is using the same mobile brand of Q and not an immediate neighbor of the person using Apple. S is not using Vivo.

**11) Who among the following persons using Apple?**

- A. T and R
- B. U and V
- C. S and R
- D. P and S
- E. None of these

**12) Four of the following five are alike in a certain way and thus form a group as per the given arrangement. Which of the following does not belong to that group?**

- A. SR
- B. UV
- C. PQ
- D. WT
- E. RV

**13) If all the persons are arranged in alphabetical order starting from P in an anticlockwise direction, then how many persons remain in the same position including P?**

- A. One
- B. Two
- C. Three
- D. Four
- E. No one

**14) If R is related to U and P is related to Q, then who among the following is related to T?**

- A. The one who sits immediate right of W
- B. U
- C. S
- D. P
- E. The one who sits opposite to Q

**15) Which of the following combination is true?**

- A. R – Apple
- B. P – Sony
- C. U – Oppo
- D. T – Vivo
- E. All of the above

**Direction (16-20): Study the following information carefully and answer the questions given below.**

Eight people P, Q, R, S, T, U, V, and W are sitting at a square table. All of them are facing the center of the table. Four persons sitting at the corners of the table and four persons sitting at the middle of the sides of the table.

T is facing W, who sits second to the right of S. Two persons are sitting between S and Q, who is not an immediate neighbor of T. P sits second to the left of R, neither of them sits at the corners of the table. R and T are not immediate neighbours. At least two persons are sitting between P and V from both sides.

**16) Who among the following persons sits immediate left of V?**

- A. The person who is facing P



- B.U
- C.The person who sits immediate left of W
- D.Q
- E.Both A & D

17) How many persons are sitting between S and V?

- A.One
- B.Two
- C.Three
- D.Four
- E.None

18) If all the persons are arranged in alphabetical order starting from P in an anticlockwise direction, then how many persons remain in the same position including P?

- A.One
- B.Two
- C.Three
- D.Four
- E.None

19) Four of the following five are alike in a certain way and thus form a group as per the given arrangement. Which of the following does not belong to that group?

- A.The one who sits immediate left of U
- B.W
- C.The one who sits opposite to V
- D.T
- E.R

20) What is the position of P with respect to W?

- A.Fifth to the left
- B.Third to the left
- C.Fourth to the right
- D.Fifth to the right
- E.Both B & D

**Directions (21-25): Study the following information carefully and answer the questions given below.**

Six boxes viz. A, B, C, D, E, and F are placed one above the other in six different shelves such that the lowermost shelf is numbered as 1 and the box immediately above the lowermost shelf is numbered as 2 and so on till the topmost shelf is numbered as 6. Each box is of different color viz. Black, Blue, Green, Pink, Red, and Yellow. All the information is not necessarily in the same order.

A red-colored box is placed at an odd-numbered shelf and two boxes above box E. Only two boxes are placed between boxes E and F, which is green in color. The number of boxes below the green color box is the same as above box C. Black color box is placed adjacent to box C and three boxes below box D. Blue color box is placed at an even-numbered shelf and immediately above the yellow color box. Box B is neither black nor placed above box D.

21) Which of the following box is placed on shelf 2?

- A. Box B
- B. Box E

- C. Box A
- D. Box C
- E. None of these

22) How many boxes are placed between box B and the black color box?

- A. One
- B. Two
- C. Three
- D. More than three
- E. None

23) Which of the following is the color of box C?

- A. Red
- B. Blue
- C. Yellow
- D. Pink
- E. None of these

24) If all the boxes are arranged in alphabetical order from bottom to top, then how many boxes remain unchanged in their position?

- A. One
- B. Two
- C. Three
- D. More than three
- E. None

25) If D is related to yellow and E is related to pink in a certain way, then B is related to which of the following?

- A. Green
- B. Black

- C. Red
- D. Blue
- E. None of these

**Directions (26-30): Study the following information carefully and answer the below questions**

Eight persons- A, B, C, D, E, F, G and H are standing in the linear row facing the north, but not necessarily in the same order.

Only three persons stand to the right of G. Only two persons stand between G and B. F stands to the immediate right of D, both of them stand neither adjacent to B nor G. D does not stand at the end of the row. The number of persons standing to the left of D is the same as the number of persons standing to the right E. A stands third to the right of C.

26) Who among the following person stands sixth from the right end?

- A. The one who stands immediate right of G
- B. D
- C. The one who stands immediate left of A
- D. B
- E. E

27) How many persons stand between D and E?

- A. Five
- B. Same as between C and H.
- C. Two
- D. Same as between A and G.
- E. One



28) If C is related to F, D is related to A, then who among the following person is related to H?

- A.D
- B.B
- C.E
- D.A
- E.G

29) What is the position of A from the left end?

- A.First
- B.Third
- C.Fourth
- D.Second
- E.Fifth

30) Four of the following five are alike in a certain way to form a group. Find the one which does not belong to the group?

- A.DG
- B.FH
- C.AE
- D.GB
- E.CF

**Directions (31-35):** Study the following information carefully and answer the questions given below.

Nine students A, B, C, D, E, F, G, H, and I are going to a school to get their progress report one after another in sequential order but not necessarily in the same order. Two students go between A and G. Only one student goes between I and G. As many students go before A is the same as the students go after A. Only

three students go before E. Two students go between E and D. F and B does not go to the school as the first and last person. Both F and B are not going immediately after I. C and F go before B.

31) Who among the following student go to a school at last?

- A.C
- B.F
- C.The one who goes immediately after F
- D.H
- E.None of these

32) How many students go to a school after D?

- A.As many students go before E
- B.As many students go before B
- C.One
- D.Four
- E.None of these

33) Four of the following five are alike in a certain way and thus form a group as per the given arrangement. Which of the following does not belong to that group?

- A.IG
- B.AD
- C.CF
- D.EI
- E.DH

34) If C is related to H and B is related to D, then who among the following persons is related to A?

- A.E
- B.I
- C.D
- D.G
- E.No one

**35) Who among the following student goes two students before A?**

- A.E
- B.D
- C.The one who goes immediately after F
- D.F
- E.G

**Directions (36-40): Study the following information carefully and answer the below questions.**

Seven persons A, B, C, D, E, F, and G are working as a journalist in the same company with different grade positions such as Reporter, Resident Editor, Photo Editor, Sub Editor, News Editor, Assignment Editor and the Publisher. Their positions are given in ascending order such that the Publisher is the highest position & the Reporter is the lowest position. All the information is not necessarily in the same order. F is a Sub Editor. Only two persons are holding a position between F and D. A holds two positions above C. C holds an adjacent position of F. The number of persons holding the position between D and C is the same as the number of persons holding the positions between B and A.

E holds an adjacent position of B. G holds the higher position to A.

**36) Who among the following person is a Photo Editor?**

- A. A
- B. The one who is immediately junior to G
- C. The one who is immediately senior to F
- D. C
- E. B

**37) Four of the following are alike in a certain way. Who among the following ones does not belong to that group?**

- A. D-Assignment Editor
- B. C-Resident Editor
- C. E-News Editor
- D. F- Photo Editor
- E. A-Sub Editor

**38) Which of the following statements is/are true?**

- A. D is the Publisher
- B. A is a Photo Editor
- C. Only two persons are holding the position between A and G
- D. C is senior to D
- E. None of these

**39) How many persons are senior to A?**

- A. Three
- B. Four
- C. One
- D. Five

E. Two

40) If D is related to News editor and C is related to Reporter in a certain way, then who among the following is related to Sub Editor?

- A. The one who holds the immediate junior position to A
- B. G
- C. B
- D. The one who holds the immediate senior position to B
- E. None of the above

**Direction (41-45): Study the following information carefully and answer the questions given below.**

Eight persons A, B, C, D, E, F, G, and H are attending online exams on different dates 5<sup>th</sup> and 8<sup>th</sup> of four different months January, February, April, and May. Only one person attends the online exam on a day.

D attends the online exam on the 8<sup>th</sup> of a month having less than 31 days. Two persons attend the online exam between D and G. Only one person attends the online exam between A and B, who attends the online exam immediately before G. As many persons attend the online exam before A is same as the persons attend the online exam after F. C attends the online exam on 5<sup>th</sup> but not on the month having less than 30 days. E attends the exam after H, but not immediately after H.

41) Who attends the exam on January 5<sup>th</sup>?

A. H

B. A

C. The person who attends immediately before B

D. Both A & C

E. Both B & C

42) Who among the following persons attend the online exam in February month?

- A. The persons who attend exactly between H and B
- B. The persons who attend exactly between D and H
- C. The persons who attend exactly between B and E
- D. C
- E. None of these

43) Four of the following five are alike in a certain way and thus form a group as per the given arrangement. Which of the following does not belong to that group?

- A. B
- B. C
- C. E
- D. H
- E. G

44) If the H is related to E and B is related to C, then who among the following person is related to F?

- A. The person who attends two persons after B
- B. A





- C. The person who attends on the 8<sup>th</sup> of February
- D. The person who attends immediately after G
- E. All of the above

**45) Who among the following person combination is false?**

- A. February – 5<sup>th</sup> – G
- B. January – 8<sup>th</sup> – B
- C. April – 5<sup>th</sup> – D
- D. May – 5<sup>th</sup> – C
- E. None is false

**Directions (46-50): Study the following information carefully and answer the below questions.**

Eight people are born in different years such as 1985, 1991, 1993, 1995, 1998, 2002, 2010, and 2013. Their ages are calculated based on the year 2021.

Two persons are born between R and the person whose age is a prime value. Neither R nor W is the youngest person. Only one person is born between U and the person who is born in 2002. Q is born just before U but not just after R. Only one person is born between Q and the person who is born just after P. S's age is more than R. More than three persons are born between S and W. Sum of the ages of W and V is the same as the sum of the ages of T and P.

**46) How many persons are born between V and the person who is born in 2010?**

- A. As many persons born between S and R
- B. Two

- C. As many persons born before P
- D. Four
- E. None of these

**47) Which of the following year did T born?**

- A. 1991
- B. 1985
- C. 1998
- D. 1993
- E. Other than the given option

**48) How many persons are born before R?**

- A. Same as between P and U
- B. No one
- C. Same as between R and S
- D. Two
- E. More than three

**49) Four of the following five are alike in a certain way and hence form a group. Which is the one that does not belong to the group?**

- A. V
- B. P
- C. U
- D. R
- E. W

**50) Difference between the ages of V and \_\_\_ is the same as the age of the person who born in \_\_\_?**

- A. U, 1998
- B. P, 2010
- C. Q, 2002

D. R, 2013

E. Other than the given option

**Answer With Explanation**

Directions (1-5):

1) Answer: E

2) Answer: D

3) Answer: C

4) Answer: C

5) Answer: B

Month	Persons
January	J
February	L
March	O
April	I
May	N
June	M
July	K
September	P

We have,

- M goes in the month having less than 31 days, but not in February.
- P goes two persons after M.
- Two persons are going to the hospital between P and N.

	Case 1	Case 2
Month	Persons	Persons
January		
February		
March	N	
April	M	
May		N
June	P	M
July		
September		P

Again we have,

- As many persons go before N is one more than the persons who go after N.
- Only one person goes between J and O, who doesn't go on the month having less than 31 days.
- L goes two months before I but doesn't go before J. so case-1 is eliminated.



Top 50 Puzzle and Seating for IBPS RRB PO Pre 2021 (Based on 01<sup>st</sup> Aug 2021 Exam)

	<del>Case 1</del>	Case 2
Month	Persons	Persons
January		J
February		L
March	N	O
April	M	I
May		N
June	P	M
July		K
September		P

Direction (6-10):

6) Answer: B

7) Answer: D

8) Answer: E

9) Answer: C

10) Answer: A

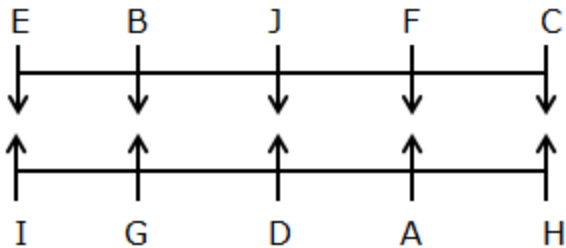

- G, who doesn't stand at the ends, stands third to the left of the one who faces C. J stands second to the right of C.

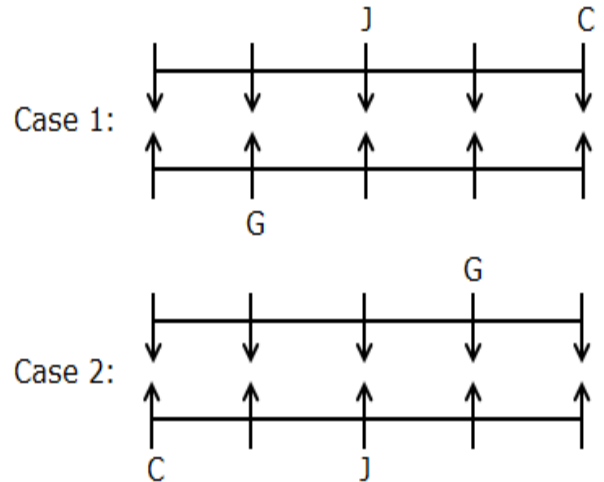

- Only one person stands between A and G who faces B. The number of persons standing to the right of B is the same as the number of persons standing to the left of F.

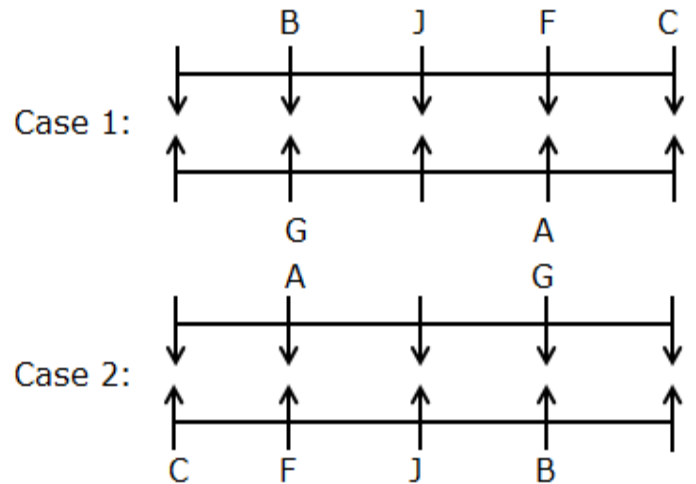

- H stands fourth to the right of I who doesn't face D. E doesn't face north. Hence, case 2 gets eliminated.



Top 50 Puzzle and Seating for IBPS RRB PO Pre 2021 (Based on 01<sup>st</sup> Aug 2021 Exam)

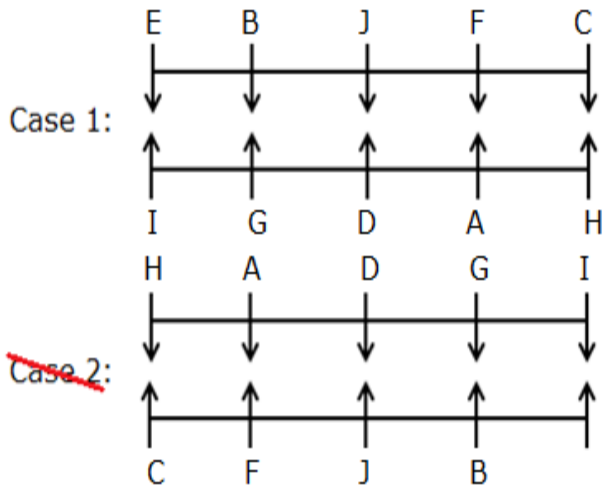

Directions (11-15):

- 11) Answer: C
- 12) Answer: E
- 13) Answer: B
- 14) Answer: C
- 15) Answer: E

Final arrangement:

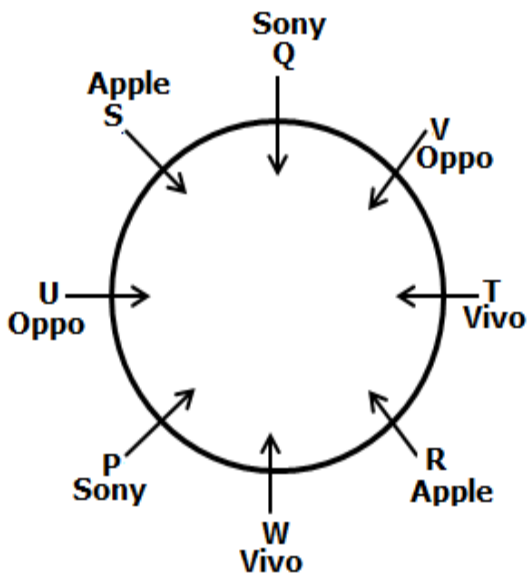

We again have,

- The person who uses Vivo is sitting second to the right of W, both of them using the same mobile brand.

- Two persons sit between W and the person who uses Oppo.

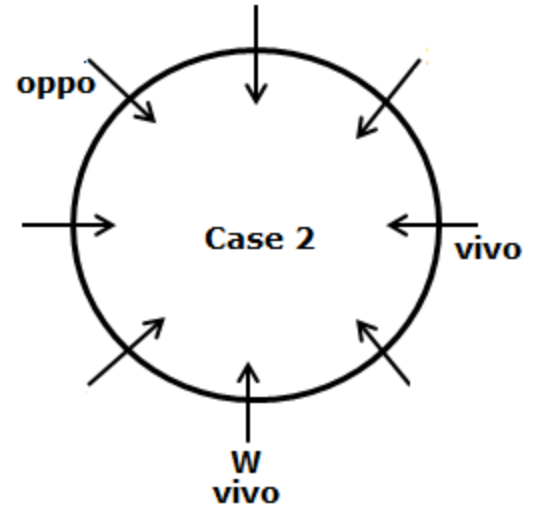
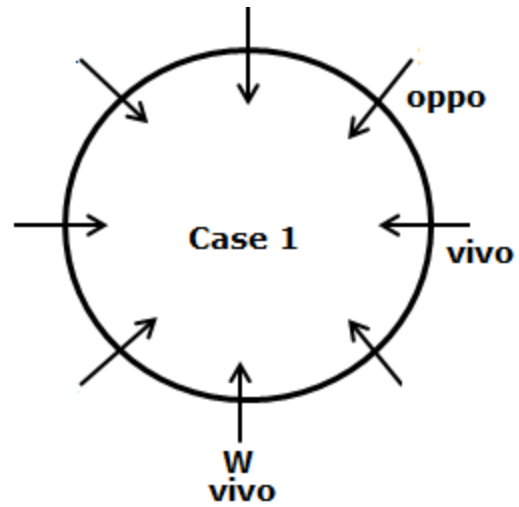

Again we have,

- Q uses Sony and sits opposite to W.
- Three persons sit between the persons who are using apple.
- One of the persons who uses apple has both the immediate neighbors are using Vivo.



Top 50 Puzzle and Seating for IBPS RRB PO Pre 2021 (Based on 01<sup>st</sup> Aug 2021 Exam)

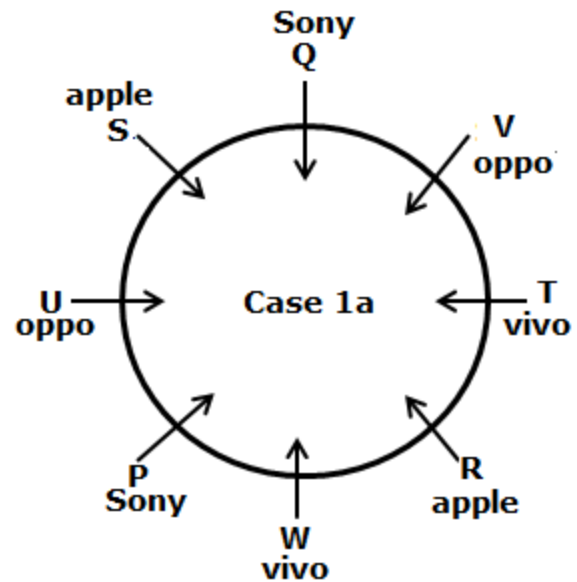
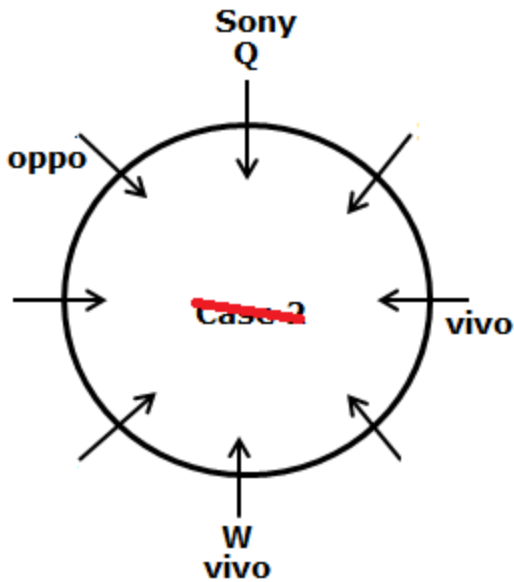
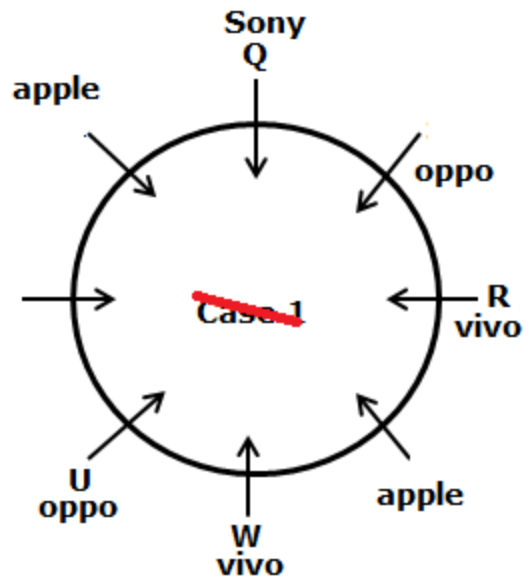
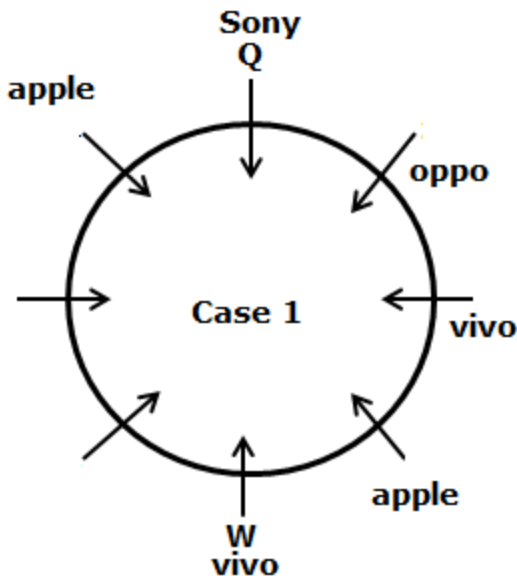

Again we have,

- U sits third to the left of R and using Oppo.
- V is not facing the person who uses Oppo and Apple.
- P is using the same mobile brand of Q and not an immediate neighbor of the person who uses Apple.
- S is not using Vivo.

Direction (16-20):

- 16) Answer: E
- 17) Answer: C
- 18) Answer: B
- 19) Answer: E
- 20) Answer: E



Top 50 Puzzle and Seating for IBPS RRB PO Pre 2021 (Based on 01<sup>st</sup> Aug 2021 Exam)

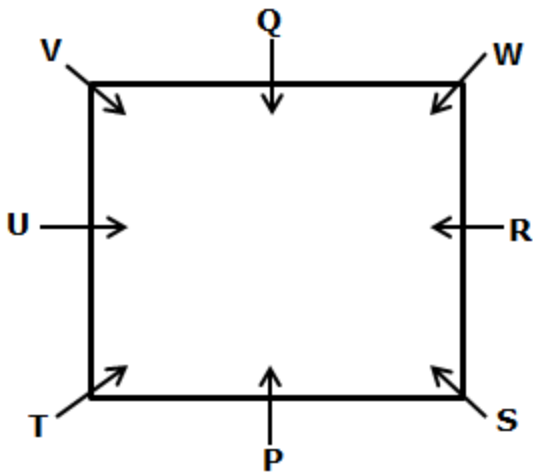

We have,

- T is facing W, who sits second to the right of S.
- Two persons are sitting between S and Q, who is not an immediate neighbor of T.

From the above condition, we have two possibilities.

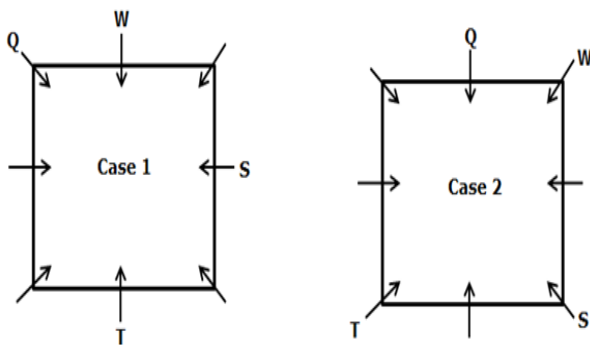

Again we have,

- P sits second to the left of R, neither of them sits at the corner of the table.
- R and T are not immediate neighbours.
- At least two persons are sitting between P and V from both sides.

From the above condition case1 gets eliminated and case2 shows the final arrangement.

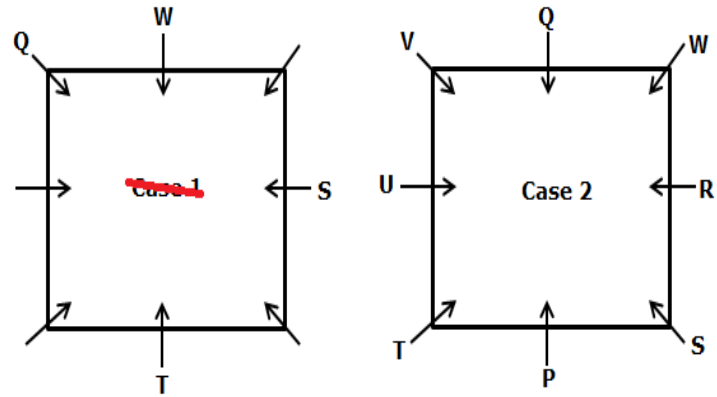

Directions (21-25):

- 21) Answer: C
- 22) Answer: A
- 23) Answer: D
- 24) Answer: A
- 25) Answer: B

Case 1		
Shelves	Boxes	Color
6	F	Green
5	D	Red
4	B	Blue
3	E	Yellow
2	A	Black
1	C	Pink

1. Red-colored box is placed at an odd-numbered shelf and two boxes above box E. Only two boxes are placed between boxes E and F, which is green in color.



Top 50 Puzzle and Seating for IBPS RRB PO Pre 2021 (Based on 01<sup>st</sup> Aug 2021 Exam)

	Case 1		Case 2	
Shelves	Boxes	Color	Boxes	Color
6	F	Green		
5		Red		
4			F	Green
3	E			Red
2				
1			E	

2. The number of boxes below the green color box is the same as above box C. Black color box is placed adjacent to box C and three boxes below box D.

	Case 1		Case 2	
Shelves	Boxes	Color	Boxes	Color
6	F	Green		
5	D	Red	D	
4			F	Green
3	E		C	Red
2		Black		Black
1	C		E	

3. Blue color box is placed at an even-numbered shelf and immediately above the yellow color box. Box B is neither black nor placed above box D.

	Case 1		<del>Case 2</del>	
Shelves	Boxes	Color	Boxes	Color
6	F	Green		Blue
5	D	Red	D	Yellow
4	B	Blue	F	Green
3	E	Yellow	C	Red
2	A	Black		Black
1	C	Pink	E	Pink

Directions (26-30):

26) Answer: C

27) Answer: B

28) Answer: D

29) Answer: C

30) Answer: E

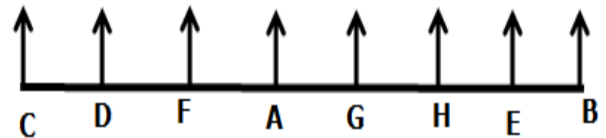

We have,

- Only three persons stand to the right of G.
- Only two persons stand between G and B.

From the above condition, there are two possibilities.



Top 50 Puzzle and Seating for IBPS RRB PO Pre 2021 (Based on 01<sup>st</sup> Aug 2021 Exam)

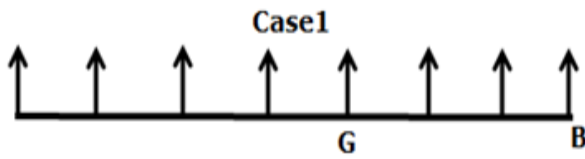

Again we have,

- F stands to the immediate right of D, both of them stands neither adjacent to B nor G.
- D does not stand at the end of the row.
- The number of persons standing to the left of D is the same as the number of persons standing to the right E.

From the above condition, case2 gets eliminated.

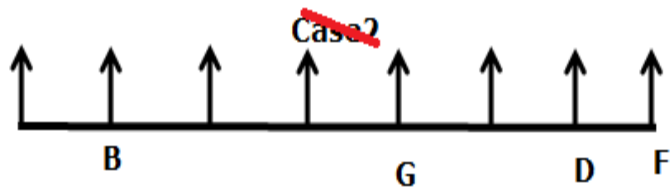
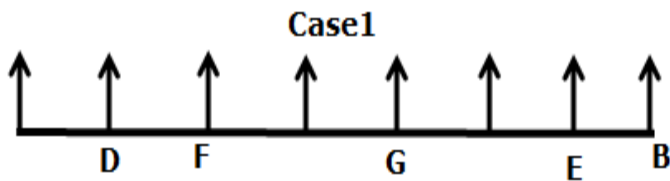

Again we have,

- A stands third to the right of C.

From the above condition, case1 shows the final arrangement.

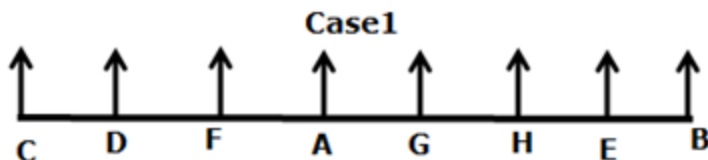

Directions (31-35):

- 31) Answer: D
- 32) Answer: B
- 33) Answer: C
- 34) Answer: E
- 35) Answer: C

Final arrangement:

Order	Students
1	C
2	F
3	B
4	E
5	A
6	I
7	D
8	G
9	H

We have,

- Two students go between A and G.
- Only one student goes between I and G.
- As many students go before A is the same as the students go after A.



**Top 50 Puzzle and Seating for IBPS RRB PO Pre 2021 (Based on 01<sup>st</sup> Aug 2021 Exam)**

	Case 1	Case 2
Order	Students	Students
1		
2		G
3		
4		I
5	A	A
6	I	
7		
8	G	
9		

Again we have,

- Only three students go before E.
- Two students go between E and D.
- F and B does not go to the school as the first and last person. Both F and B are not going immediately after I.
- C and F goes before B.

	Case 1	<del>Case 2</del>	<del>Case 1a</del>
Order	Students	Students	Students
1	C		D
2	F	G	
3	B		
4	E	I	E
5	A	A	A
6	I		I
7	D		
8	G		G
9	H		

Directions (36-40):

36) Answer: D

17) Answer: C

38) Answer: A

39) Answer: E

40) Answer: B

Final Arrangement

Designations	Persons
Publisher	D
Assignment Editor	G
News Editor	A
Sub Editor	F
Photo Editor	C
Resident Editor	E
Reporter	B

We have,

- F is a Sub Editor.
- Only two persons are holding a position between F and D.
- A holds two positions above C.
- C holds an adjacent position of F.

From the above condition, there are three possibilities.

Designations	Case-1	Case-2	Case-1a
Publisher		D	A
Assignment Editor			
News Editor	A	A	C
Sub Editor	F	F	F
Photo Editor	C	C	
Resident Editor			
Reporter	D		D

Again we have,



Top 50 Puzzle and Seating for IBPS RRB PO Pre 2021 (Based on 01<sup>st</sup> Aug 2021 Exam)

- The number of persons holding the position between D and C is the same as the number of persons holding the position between B and A.
- E holds an adjacent position of B.

Designations	Case-1	Case-2	Case-1a
Publisher	B	D	A
Assignment Editor	E	G	G
News Editor	A	A	C
Sub Editor	F	F	F
Photo Editor	C	C	B
Resident Editor	G	E	E
Reporter	D	B	D

Again we have,

- G holds a higher position to A.

From the above condition, case1 and case1a get eliminated. Case2 shows the final arrangement.

Designations	<del>Case-1</del>	Case-2	<del>Case-1a</del>
Publisher	B	D	A
Assignment Editor	E	G	G
News Editor	A	A	C
Sub Editor	F	F	F
Photo Editor	C	C	B
Resident Editor	G	E	E
Reporter	D	B	D

Directions (41-45):

- 41) Answer: D
- 42) Answer: B
- 43) Answer: E
- 44) Answer: E

45) Answer: C

Final arrangement:

Months	Dates	Persons
January	5 <sup>th</sup>	H
	8 <sup>th</sup>	B
February	5 <sup>th</sup>	G
	8 <sup>th</sup>	A
April	5 <sup>th</sup>	F
	8 <sup>th</sup>	D
May	5 <sup>th</sup>	C
	8 <sup>th</sup>	E

We have,

- D attends the online exam on the 8<sup>th</sup> of a month having less than 31 days.
- Two persons attend the online exam between D and G.

From the above condition, there are three possibilities.

		Case 1	Case 2	Case 3
Months	Dates	Persons	Persons	Persons
January	5 <sup>th</sup>		G	
	8 <sup>th</sup>			
February	5 <sup>th</sup>	G		
	8 <sup>th</sup>		D	D
April	5 <sup>th</sup>			
	8 <sup>th</sup>	D		
May	5 <sup>th</sup>			G
	8 <sup>th</sup>			

Again we have,



Top 50 Puzzle and Seating for IBPS RRB PO Pre 2021 (Based on 01<sup>st</sup> Aug 2021 Exam)

- Only one person attends the online exam between A and B, who attends the online exam immediately before G.
- As many persons attend the online exam before A as the persons who attend the online exam after F.
- C attends the online exam on the 5<sup>th</sup> but not on the month having less than 30 days.
- E attends the exam after H, but not immediately after H.

		Case 1	<del>Case 2</del>	<del>Case 3</del>
Months	Dates	Persons	Persons	Persons
January	5 <sup>th</sup>	H	G	F
	8 <sup>th</sup>	B		
February	5 <sup>th</sup>	G		
	8 <sup>th</sup>	A	D	D
April	5 <sup>th</sup>	F		
	8 <sup>th</sup>	D		B
May	5 <sup>th</sup>	C		G
	8 <sup>th</sup>	E		A

Directions (46-50):

- 46) Answer: D
- 47) Answer: C
- 48) Answer: D
- 49) Answer: E
- 50) Answer: C

Age	Year	Persons
36	1985	S
30	1991	V
28	1993	R
26	1995	P
23	1998	T
19	2002	W
11	2010	Q
8	2013	U

Two persons are born between R and the person whose age is a prime value. Neither R nor W is the youngest person.

		Case I	Case II	Case III
Age	Year	Persons	Persons	Persons
36	1985			
30	1991			R
28	1993		R	
26	1995	R		
23	1998			
19	2002			
11	2010			
8	2013			

Only one person is born between U and the person who is born in 2002.

Q is born just before U but not born just after R.



Top 50 Puzzle and Seating for IBPS RRB PO Pre 2021 (Based on 01<sup>st</sup> Aug 2021 Exam)

		Case I	Case II	Case III
Age	Year	Persons	Persons	Persons
36	1985			
30	1991			R
28	1993		R	
26	1995	R		
23	1998			
19	2002			
11	2010	Q	Q	Q
8	2013	U	U	U

Only one person is born between Q and the person who is born just after P.

S's age is more than R. More than three persons are born between S and W.

		<del>Case I</del>	Case II	Case III
Age	Year	Persons	Persons	Persons
36	1985		S	S
30	1991			R
28	1993		R	
26	1995	R	P	P
23	1998			
19	2002		W	W
11	2010	Q	Q	Q
8	2013	U	U	U

Sum of the ages of W and V is the same as the sum of the ages of T and P.

		Case II	<del>Case III</del>
Age	Year	Persons	Persons
36	1985	S	S
30	1991	V	R
28	1993	R	
26	1995	P	P
23	1998	T	
19	2002	W	W
11	2010	Q	Q
8	2013	U	U