

Top 50 Important Seating Arrangement Questions



Crack with Jack

All in One Package of CWJ

Video Course | Mock Test | Ebooks | Bundle PDF |
PDF Course

Validity : 24 Months

SUBSCRIBE NOW



Directions (1-5): Study the following information carefully and answer the questions given below.

Eight fans - A, B, C, D, E, F, G and H are kept around a square table such that four fans are kept on the corners and facing towards the centre while four of the fans are kept in the middle of the sides and facing away from the centre. They belong to different brands viz., Usha, Havells, Kenstar, Bajaj, Cello, Orient, Voltas and Crompton, but not necessarily in the same order.

B is kept third to the right of the Kenstar fan. Only three fans are kept between H and D, which is not kept in the middle of the sides. E belongs to Voltas brand and is kept immediate right of H. Neither D nor H belongs to Kenstar brand. The Crompton fan is kept second to the right of D, which belongs to Havells. C is kept second to the left of the Havells fan. The Bajaj fan is kept three places away from the Havells fan. G is kept opposite to Bajaj fan. F faces the

fan which is kept immediate right of the Orient fan. The Cello fan is not kept adjacent to A.

1) Which of the following fan is kept second to the left of A?

- a) C
- b) B
- c) A
- d) E
- e) None of these

2) Which of the following fan is kept exactly between G and the Cello fan, when counted from the left of G?

- I. The fan which is kept opposite to H.
 - II. The fan which is kept immediate right of C.
 - III. The fan which is kept second to the right of H.
- a) Only (I)
 - b) Only (II)
 - c) Only (II) and (III)
 - d) Only (III)
 - e) All (I), (II) and (III)

Top 50 Important Seating Arrangement Questions

3) What is the position of B with respect to the Orient fan?

- a) Third to the left
- b) Second to the right
- c) Fourth to the right
- d) Second to the left
- e) None of the above

4) Four of the following five are alike in a certain way as per the given arrangement and hence form a group. Find the one that doesn't belong to that group.

- a) The Usha fan
- b) The Cello fan
- c) The Voltas fan
- d) The Bajaj fan
- e) The Orient fan

5) How many fans are kept between D and the Bajaj fan, when counted from the left of D?

- a) None
- b) One
- c) Two
- d) Three
- e) More than three

Directions (6-10): Study the following information carefully and answer the questions given below.

Nine persons - L, M, N, O, P, Q, R, S, and T are sitting in a straight line such that all of them are facing towards South, but not necessarily in the same order.

S sits fourth to the right of M, where none of them sits at the end of the row. Only one person sits between S and R, who sits to the left of S. The number of persons sitting to the right of S is one less than the number of persons sitting to the left of O. Only two persons sit between O and P. As many persons sit between P and S is same as between Q and T. L sits second to the left of Q.

6) Who among the following person sits second to the left of N?

- A. The one who sits immediate right of R
- B. T
- C. The one who sits third to the right of O
- D. P
- E. Both c and d

7) As many persons sit to the left of L as to the right of ____.

- A. The one who sits immediate right of M
- B. T
- C. M
- D. The one who sits immediate left of Q
- E. The one who sits at the right end of the row

8) What is the position of T with respect to R?

- A. Second to the left
- B. Immediate right
- C. Second to the right
- D. Fourth to the right
- E. Third to the left

Top 50 Important Seating Arrangement Questions

9) If all the persons are made to sit in the alphabetical order from the left end, then how many persons remain unchanged in their position?

- A. One
- B. Two
- C. Three
- D. More than three
- E. No one

10) Who among the following person sits immediate left of the one who sits second to the right of P?

- A. L
- B. The one who sits third to the left of R
- C. N
- D. The one who sits immediate left of Q
- E. None of these

Direction (11-15): Study the following information carefully and answer the questions given below.

Eight persons viz. A, B, C, D, E, F, G, and H are sitting around a circular table such that all of them are facing towards the center. The consecutive alphabetically named persons are not sitting adjacent to each other.

Two persons sit between A and C, who faces E.

Only one person sits between A and F. The number of persons sitting between E and F is twice the number of persons sitting between C and H when counted from the right of both F and C. D sits exactly between B and G, who doesn't sit adjacent to E.

11) Who among the following person sits second to the left of C?

- a) The one who sits to the immediate right of E
- b) G
- c) The one who sits third to the right of A
- d) H
- e) None of these

12) What is the position of F with respect to H?

- a) Fourth to the right
- b) Immediate left
- c) Second to the left
- d) Third to the right
- e) None of these

13) If all the persons are made to sit in the alphabetical order with respect to A in a clockwise direction, then how many persons remain unchanged in their position, excluding A?

- a) One
- b) Two
- c) Three
- d) More than three
- e) None

14) Find out the series that follow the same logic.

DG FA BC ____

- a) HD
- b) FE
- c) HB
- d) AG
- e) None of these

Top 50 Important Seating Arrangement Questions

15) Which of the following statement is/are true with respect to the final arrangement?

- I. Neither B nor H sits adjacent to E.
 - II. More than one person sits between E and G when counted from both sides.
 - III. A sits exactly between B and F.
- a) Only I
 - b) Only III
 - c) Both I and II
 - d) Both II and III
 - e) None of these

Directions (16-20): Study the following information carefully and answer the questions given below.

A certain number of persons are sitting in a straight line such that all of them are facing towards North. Not more than 22 persons are there in the row. Only eight persons sit between P and R. J sits third to the left of P. Only five persons sit between J and O. O does not sit exactly between J and R. C sits immediately left of O. Only four persons sit between C and S. The numbers of persons sitting between S and P is the same as the number of persons sitting between P and T. Only three persons sit between T and B. M sits at the end of the row. Q sits exactly between B and M. Not more than two persons sit between M and R.

16) What is the position of Q with respect to P?

- a) Fourth to the right
- b) Fifth to the left

- c) Ninth to the right
- d) Seventh to the left
- e) Sixth to the right

17) How many persons sit between M and J?

- a) As many persons sit to the right of T
- b) Fifteen
- c) As many persons sit to the left of Q
- d) Twelve
- e) As many persons sit between S and R

18) The number of persons sitting between C and B is the same as the number of persons sitting to the right of ____.

- a) The one who sits third to the left of T
- b) B
- c) The one who sits fourth to the right of S
- d) T
- e) The one who sits exactly between Q and B

19) If the position of O and Q are interchanged, then who among the following person sits fourth to the right of Q?

- a) Not known
- b) The one who sits fourth to the left of P
- c) The one who sits sixth to the right of C
- d) The one who sits second from the left end
- e) The one who sits second to the left of J

20) If I sits second to the left of R, then how many persons sit between I and S?

- a) As many persons sit between Q and R
- b) Ten

Top 50 Important Seating Arrangement Questions

- c) As many persons sit to the right of B
- d) As many persons sit between J and R
- e) Thirteen

Directions (21-25): Study the following information carefully and answer the questions given below.

Ten persons are sitting in a parallel row and facing each other. In Row 1 D, E, F, G and H are sitting and all of them face north. In Row 2 L, M, N, O and P are sitting and all of them face south. Five persons like different colours viz., Red, Green, White, Blue and Black and the remaining persons like different fruits viz., Banana, Plum, Grapes, Apple and Mango.

Only one person sits between G who likes white and the one who faces P. Neither G nor P sits at the extreme ends. As many persons sit to the right of P is same as to the left of O. Only three persons sit between the one who faces the one who likes mango and N who doesn't sit adjacent to O. F likes grapes and sits diagonally opposite to M. M sits adjacent to the one who likes apple. F sits two places away from the one who sits opposite to the one who likes black. The one who likes green faces the one who likes grapes. The one who likes blue sits immediate left of the one who likes grapes. E likes plum. Neither M nor H likes fruits.

21) Who among the following person likes Black colour?

- a) The one who sits opposite to H
- b) The one who sits adjacent to M

- c) The one who sits opposite to the one who likes Grapes
- d) Both (a) and (b)
- e) None of these

22) Who among the following is an immediate neighbour of one who likes green?

- a) The one who likes Black
- b) The one who likes Banana
- c) The one who likes Red
- d) The one who likes Apple
- e) None of these

23) How many persons sit between the one who likes grapes and the one who sits opposite to O?

- a) No one
- b) One
- c) Three
- d) Two
- e) None of these

24) If M is related to Plum, L is related to Grapes, then who among the following is related to Blue?

- a) D
- b) G
- c) N
- d) P
- e) None of these

25) Who among the following person sits opposite to the one who likes white?

- a) The one who likes green
- b) The one who likes Apple

Top 50 Important Seating Arrangement Questions

- c) The one who likes banana
- d) The one who likes plum
- e) None of these

Directions (26-30): Study the following information carefully and answer the questions given below.

Eight persons - K, L, M, N, O, P, Q and R are sitting around a rectangular table facing outside, but not necessarily in the same order. Four persons are sitting on the corners while four persons are sitting in the middle of the sides of the table.

N sits third to the left of M. One person sits between N and L, who doesn't sit adjacent to M. K sits opposite to O, who is the immediate neighbor of L. The number of persons sitting between Q and R is one more than the number of persons sitting between P and R. R doesn't sit opposite to L. P sits on one of the sides of the table.

26) Who among the following person sits immediate right of Q?

- A. M
- B. The one who sits immediate left of P
- C. R
- D. The one who sits second to the right of L
- E. O

27) Who among the following persons sit adjacent to R?

- A. K and Q
- B. M and O

- C. L and N
- D. P and M
- E. None of these

28) What is the position of O with respect to the one who sits third to the right of L?

- A. Immediate left
- B. Third to the right
- C. Exactly opposite
- D. Second to the left
- E. Fifth to the right

29) How many persons sit between P and N, when counted from the left of N?

- A. As many persons sit between K to O when counted from the right of K
- B. Four
- C. As many persons sit between L to M when counted from the left of L
- D. Five
- E. One

30) Four of the following five are alike in a certain way as per the given arrangement and hence form a group. Find the one who doesn't belong to that group.

- A. R
- B. N
- C. L
- D. P
- E. K

Top 50 Important Seating Arrangement Questions

Directions (31-35): Study the following information carefully and answer the questions given below.

Six persons- R, S, T, U, V and W are sitting around a triangular table in such a way that three persons are sitting in the corners facing inside whereas three persons are sitting in the middle of the sides facing outside. Each person likes different chat items viz. Sevpuri, Dahipuri, Bhelpuri, Panipuri, PavBhaji and Kachori.

R who doesn't like Sevpuri sits second to the right of the one who likes PavBhaji. Only two persons sit between the one who likes PavBhaji and Dahipuri. U sits opposite to the one who likes Kachori and facing inside. W likes neither Panipuri nor Sevpuri. S sits second to the left of T and likes Bhelpuri. V is an immediate neighbor of S but doesn't like PavBhaji.

31) U likes which among the following chat item?

- a) Kachori
- b) Bhelpuri
- c) Sevpuri
- d) Panipuri
- e) Dahipuri

32) Who among the following person sits third to the left of the one who likes Dahipuri?

- a) S
- b) The one who likes PavBhaji
- c) U
- d) The one who likes Kachori
- e) T

33) Who among the following person sits to the immediate right of R?

- a) V
- b) The one who likes Panipuri
- c) The one who likes Bhelpuri
- d) The one who likes Dahipuri
- e) U

34) Who among the following person likes Kachori?

- a) W
- b) T
- c) R
- d) U
- e) V

35) If T is related to W and S is related to R in a certain way, then who among the following person is related to U?

- a) S
- b) The one who likes PavBhaji
- c) V
- d) The one who likes Kachori
- e) Both C & D

Directions (36-40): Study the following information carefully and answer the questions given below.

Seven persons - G, H, I, J, K, L and M are sitting around a circular table facing inside the table, but not necessarily in the same order. Each person wears jewelry of different metals - Silver,

Top 50 Important Seating Arrangement Questions

Gold, Diamond, Steel, Copper, Platinum and Nickel.

K sits second to the right of L, who wears Silver. The person, who wears Diamond, sits adjacent to K. Three persons sit between the one who wears Diamond and J, who is not an immediate neighbor of L. G wears Copper but does not sit adjacent to J. The person, who wears Steel, sits third to the right of G. Neither M nor the one who sits adjacent to H wears Steel. The person, who wears Nickel, sits third to the left of H. K does not wear Platinum.

36) Who among the following person wears Gold?

- a) The one who sits immediate left of H
- b) The one who sits third to the right of I
- c) The one who sits second to the right of M
- d) The one who sits third to the left of L
- e) The one who sits immediate right of the one who wears Platinum

37) How many persons sit between H and the one who wears Platinum, when counted from the left of H?

- a) As many persons sit between L and M, when counted from the left of L
- b) One
- c) Four
- d) As many persons sit between the one who wears Gold and the one who wears Copper
- e) As many persons sit between G and I, when counted from the right of I

38) _____ sits second to the right of M.

- a) The one who wears Nickel
- b) The one who sits immediate right of H
- c) The one who wears Silver
- d) The one who wears Steel
- e) The one who sits third to the left of the one who wears Silver

39) Which of the following combination is false with respect to the final arrangement?

- a) M-Diamond
- b) L-Silver
- c) K-Gold
- d) J-Nickel
- e) I-Steel

40) What is the position of I with respect to the one who wears Gold?

- a) Second to the left
- b) Fifth to the right
- c) Fourth to the left
- d) Third to the right
- e) Fourth to the right

Directions (41-45): Study the following information carefully and answer the questions given below.

Eight persons viz. S, T, U, V, W, X, Y and Z are standing on a straight line such that all of them are facing towards north, but not necessarily in the same order.

X stands second from one of the extreme ends of the row. T stands second to the left of V, who

Top 50 Important Seating Arrangement Questions

stands adjacent to X. The number of persons to the left of T is the same as to the right of Y. More than two persons stand between Y and U (either on right or on left). S neither stands adjacent to U nor T. The number of persons between S and Z is one less than between W and S, who doesn't stand adjacent to Y.

41) Who among the following person stands second to the left of T?

- A. The one who stands to the immediately right of U
- B. Z
- C. V
- D. No such person
- E. None of these

42) How many persons stand between S and X?

- A. One
- B. Two
- C. Three
- D. More than three
- E. None

43) What is the position of V with respect to Z?

- A. Fifth to the left
- B. Third to the right
- C. Fourth to the left
- D. Fourth to the right
- E. None of these

44) The number of persons standing between U and V is the same as between ____.

- A. Y and U

- B. T and X
- C. X and W
- D. S and Y
- E. None of these

45) If all the persons are made to stand in the alphabetical order from left to right, then how many persons remain unchanged in their position?

- A. One
- B. Two
- C. Three
- D. More than three
- E. None

Direction (46-50): Study the following information carefully and answer the questions given below.

Twelve persons are sitting in a parallel rows and facing each other. In row1 G, H, I, J, K and L are seated and all of them face north. In row2 P, Q, R, S, T and U are seated and all of them face south.

H sits four places away from the one who sits opposite to Q. K sits adjacent to H who doesn't sit at the extreme ends. K sits opposite to the one who sits second to the left of S. T sits opposite to the one who sits second to the left of J. J sits neither opposite to Q nor adjacent to K. R sits to the immediate left of T. As many persons sit between T and R is same as between G and L who sits opposite to S. I does not sit at the extreme ends of the row. U sits towards the left of P.

Top 50 Important Seating Arrangement Questions

46) Who among the following person sits opposite to the one who sits second to the left of P?

- a) G
- b) J
- c) H
- d) K
- e) None of these

47) If Q is related to I and P is related to H in a certain way, then who among the following person is related to J?

- a) U
- b) S
- c) R
- d) T
- e) None of these

48) Which of the following statements is/are true?

- a) H sits to the immediate right of K

b) S sits opposite to L

c) P sits opposite to the one who sits second to the right of G

d) All are true

e) None of these

49) Who among the following person sits adjacent to I?

a) The one who sits opposite to S

b) The one who sits opposite to R

c) The one who sits second to the right of G

d) Both (a) and (c)

e) None of these

50) How many persons are sitting between U and the one who sits opposite to L?

a) Four

b) Two

c) Three

d) One

e) None of these

Answer with Explanation

Directions (1-5):

1) Answer: D

2) Answer: A

3) Answer: D

4) Answer: A (All the fans are kept in the middle of the sides, except option A)

5) Answer: E

Final Arrangement:

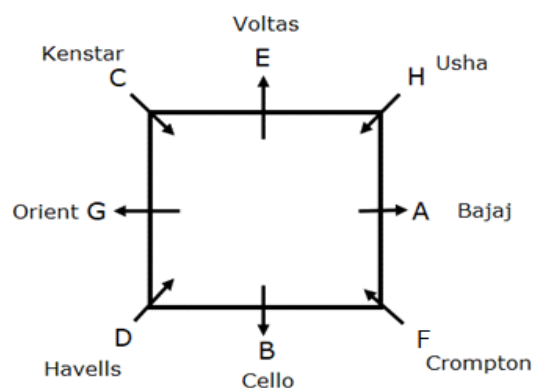

We have,

Top 50 Important Seating Arrangement Questions

- B is kept third to the right of the Kenstar fan.
- Only three fans are kept between H and D, which is not kept in the middle of the sides.
- E belongs to Voltas brand and is kept immediate right of H.
- Neither D nor H belongs to Kenstar brand.

From the above conditions, there are two possibilities

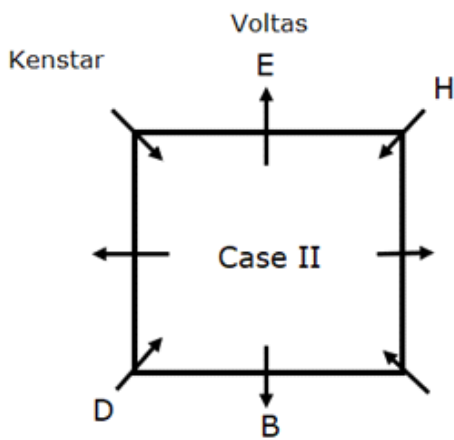
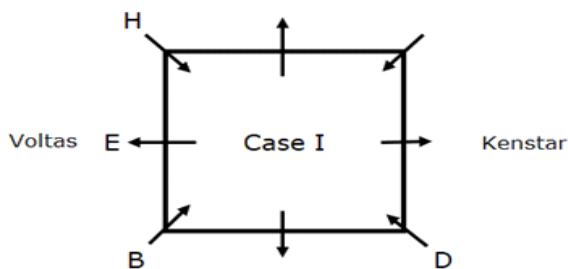

Again we have,

- The Crompton fan is kept second to the right of D, which belongs to Havells.
- C is kept second to the left of the Havells fan.
- The Bajaj fan is kept three places away from the Havells fan.

From the above condition, case I gets eliminated.

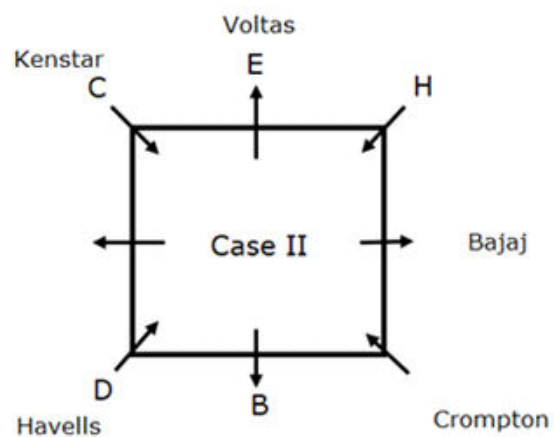
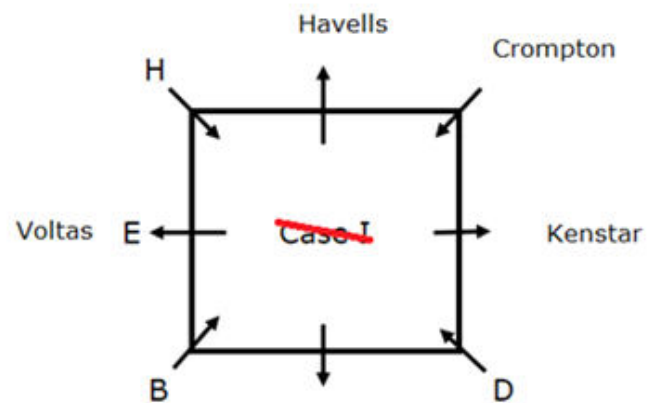

Again we have,

- G is kept opposite to Bajaj fan.
- F faces the fan which is kept immediate right of the Orient fan.
- The Cello fan is not kept adjacent to A.

From the above condition, case II shows the final arrangement.

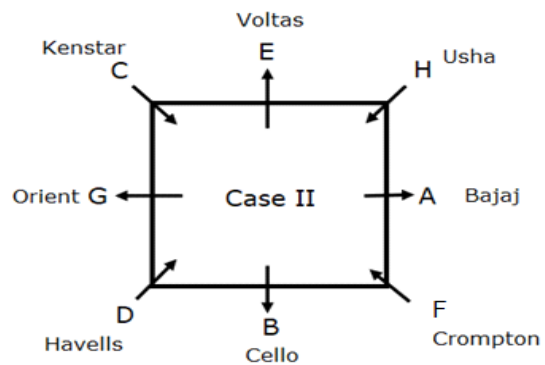

Directions (6-10):

6) Answer: C

7) Answer: A

Top 50 Important Seating Arrangement Questions

8) Answer: E

9) Answer: A

10) Answer: B

Final arrangement

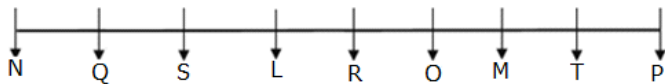

We have,

- S sits fourth to the right of M, where none of them sits at the end of the row.
- Only one person sits between S and R, who sits to the left of S.

From the above condition, there are three possibilities

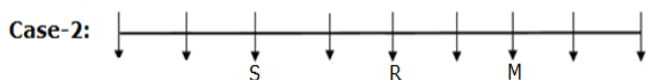
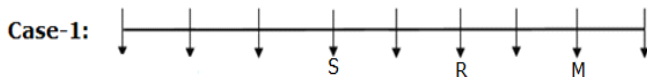

Again we have,

- The number of persons sitting to the right of S is one less than the number of persons sitting to the left of O.
- Only two persons sit between O and P.

From the above condition, case3 gets eliminated.

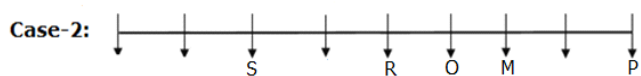
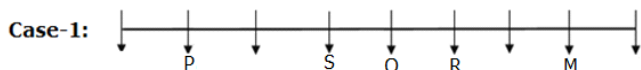

Again we have,

- As many persons sit between P and S as between Q and T.
- L sits second to the left of Q.

From the above condition, case1 gets eliminated. Hence, case 2 shows the final arrangement.



Directions (11-15):

11) Answer: C

12) Answer: B

13) Answer: E

14) Answer: A

15) Answer: D

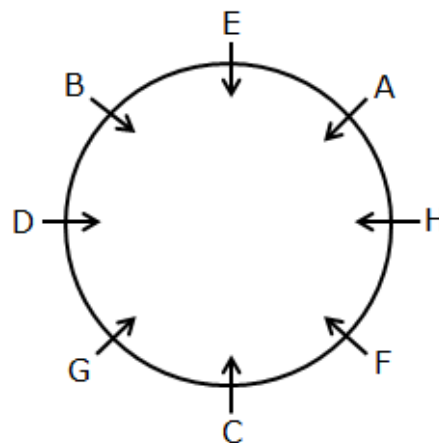

- Two persons sit between A and C, who faces E.
- Only one person sits between A and F.

Top 50 Important Seating Arrangement Questions

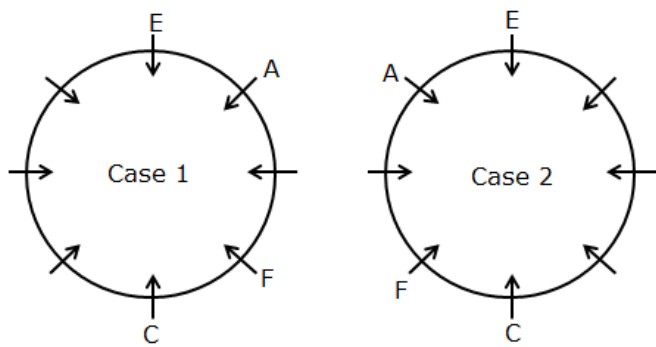

- The number of persons sitting between E and F is twice the number of persons sitting between C and H when counted from the right of both F and C.
- D sits exactly between B and G, who doesn't sit adjacent to E.
- The consecutive alphabetically named person doesn't sit adjacent to each other.

Hence, case 2 gets eliminated.

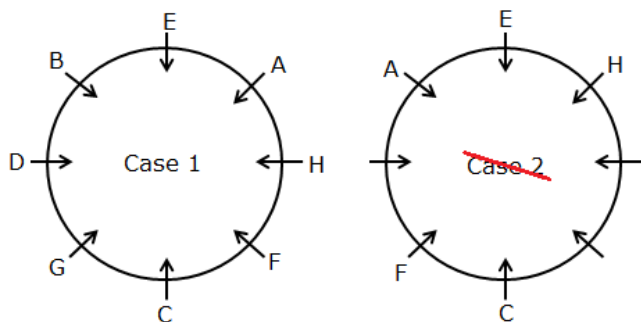

Directions (16-20):

- 16) Answer: E
- 17) Answer: E
- 18) Answer: B
- 19) Answer: E
- 20) Answer: D

Final arrangement

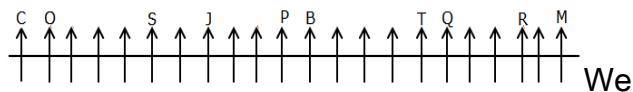

have,

- Only eight persons sit between P and R.
- J sits third to the left of P.

- Only five persons sit between J and O. O does not sit exactly between J and R.

From the above condition, there are two possibilities.

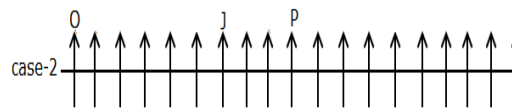
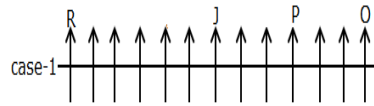

Again we

have,

- C sits immediate left of O.
- Only four persons sit between C and S.
- The numbers of persons sitting between S and P is the same as the number of persons sitting between P and T.

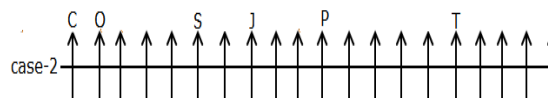
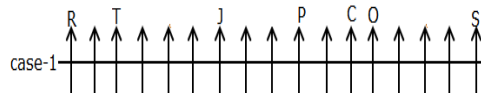

Again

we have,

- Only three persons sit between T and B.
- M sits at the end of the row.
- Q sits exactly between B and M. Not more than two persons sit between M and R.

From the above condition, case-1 gets eliminated. Hence, case-2 shows the final arrangement.

Top 50 Important Seating Arrangement Questions

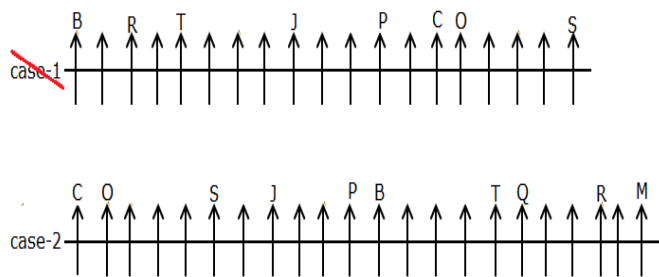

Directions (21-25):

21) Answer: E

22) Answer: B

23) Answer: D

24) Answer: E

25) Answer: B

Final arrangement:

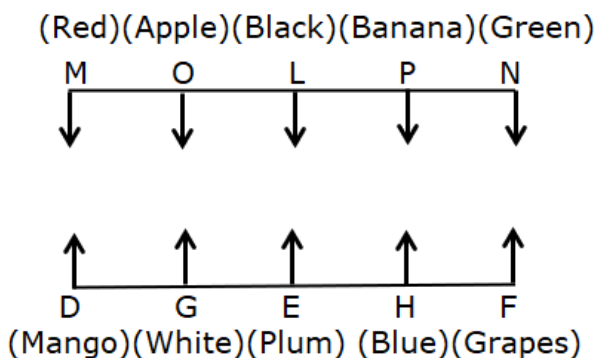

We have,

- Only one person sits between G who likes white and the one who faces P.
- Neither G nor P sits at the extreme ends.
- As many persons sit to the right of P as to the left of O.

From the above conditions, there are two possibilities

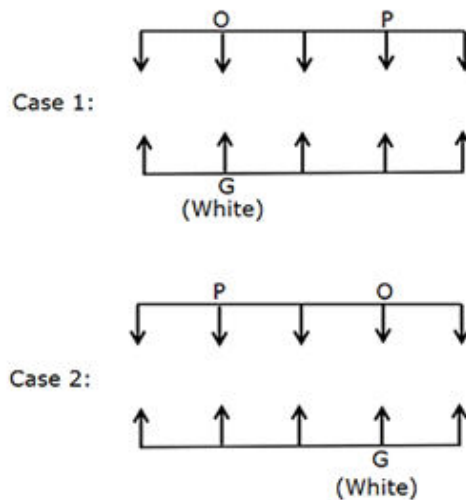

Again

we have,

- Only three persons sit between the one who faces the one who likes mango and N who doesn't sit adjacent to O.
- F likes grapes and sits diagonally opposite to M.
- M sits adjacent to the one who likes apple.

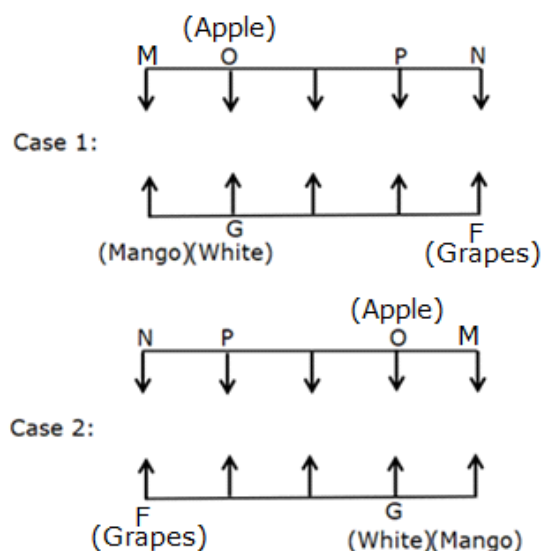

Again

we have,

- F sits two places away from the one who sits opposite to the one who likes black.

Top 50 Important Seating Arrangement Questions

- The one who likes green faces the one who likes grapes.
- The one who likes blue sits immediate left of the one who likes grapes.

So Case 2 gets eliminated

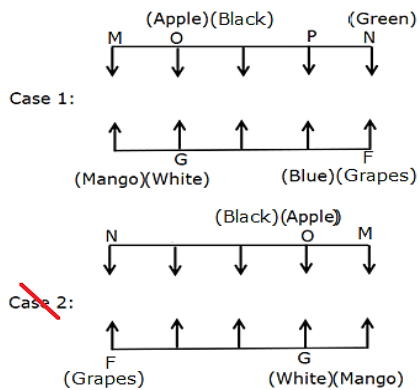

Again we have,

- E likes plum.
- Neither M nor H likes fruits.

Hence Case 1 shows the final arrangement

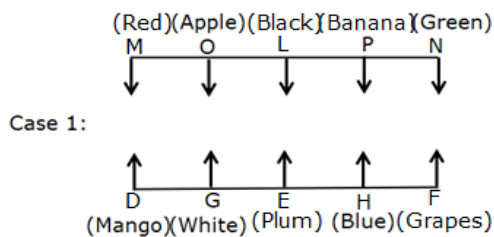

Directions (26-30):

- 26) Answer: D
 27) Answer: B
 28) Answer: C
 29) Answer: D

30) Answer: E (All the persons sit in the sides of the table, except option E.)

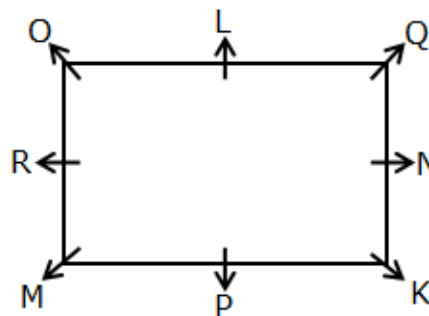

We have,

- N sits third to the left of M.
- One person sits between N and L, who doesn't sit adjacent to M.
- K sits opposite to O, who is the immediate neighbor of L.

From the above conditions, there are two possibilities.

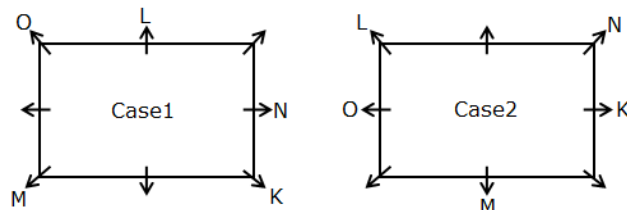

- The number of persons sitting between Q and R is one more than the number of persons sitting between P and R.
- R doesn't sit opposite to L.
- P sits on one of the sides of the table.

From the above conditions, Case 2 gets eliminated. Hence, Case 1 shows the final arrangement.

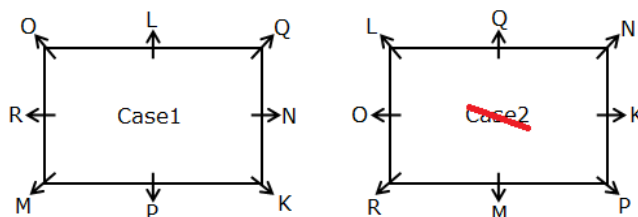

Top 50 Important Seating Arrangement Questions

Directions (31-35):

31) Answer: C

32) Answer: B

33) Answer: D

34) Answer: E

35) Answer: E

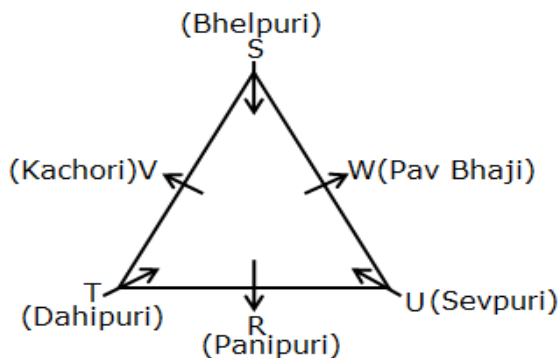

We have,

- R who doesn't like Sevpuri sits second to the right of the one who likes PavBhaji.
- Only two persons sit between the one who likes PavBhaji and Dahipuri.
- U sits opposite to the one who likes Kachori and facing inside.

From the above conditions, there are three possibilities.

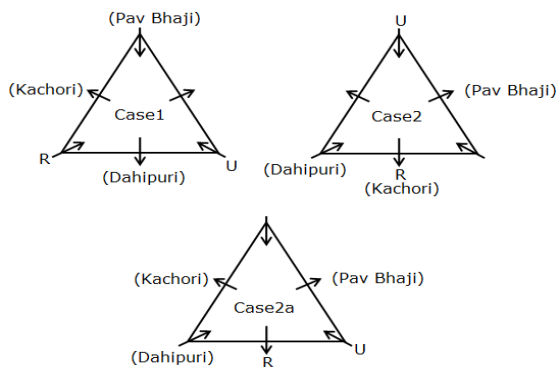

Again we

have,

- W likes neither Panipuri nor Sevpuri.
- S sits second to the left of T and likes Bhelpuri.

- V is an immediate neighbor of S but doesn't like PavBhaji.

From the above conditions, Case1 and Case2 get eliminated. Hence Case2a shows the final arrangement.

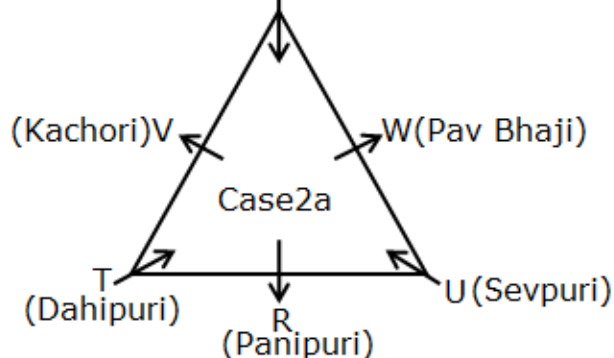
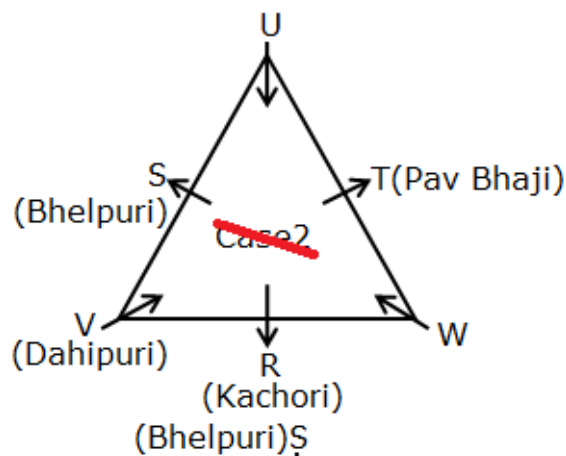
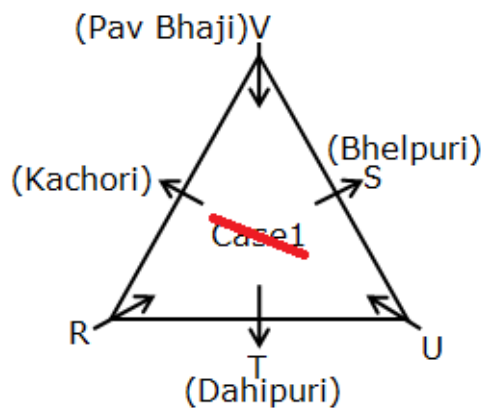

Directions (36-40):

36) Answer: B

37) Answer: E

38) Answer: D

39) Answer: A

Top 50 Important Seating Arrangement Questions

40) Answer: E

Final arrangement

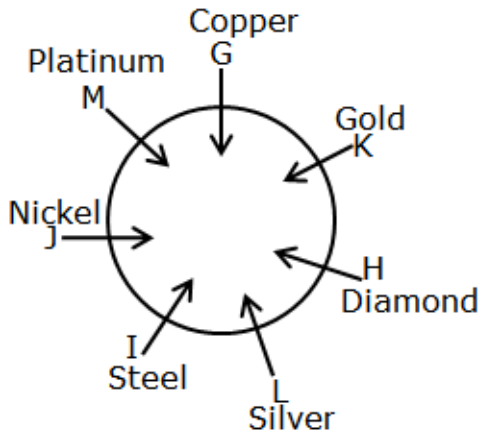

We have,

- K sits second to the right of L, who wears Silver.
- The person, who wears Diamond, sits adjacent to K.
- Three persons sit between the one who wears Diamond and J, who is not an immediate neighbor of L.

From the above condition, there are three possibilities. Case-1a gets eliminated

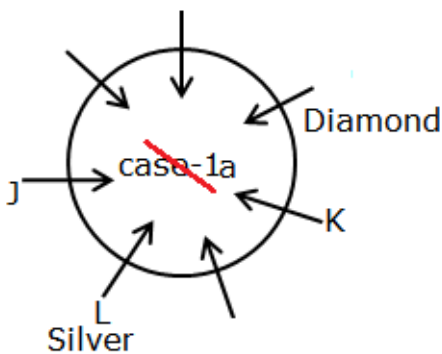
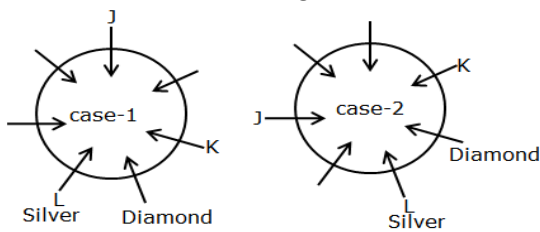

Again we have,

- G wears Copper but does not sit adjacent to J.
- The person, who wears Steel, sits third to the right of G.

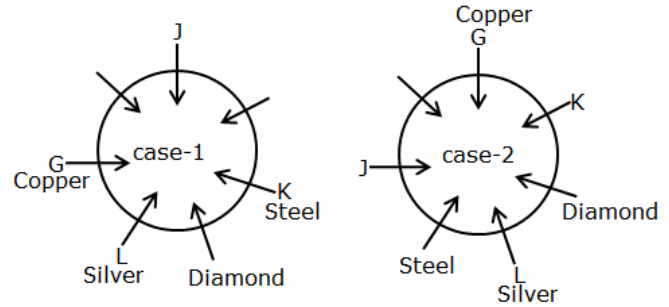

gain we have,

- Neither M nor the one who sits adjacent to H wears Steel.
- The person, who wears Nickel, sits third to the left of H.
- K does not wear Platinum.

From the above condition, case-1 gets eliminated. Hence, case-2 shows the final arrangement.

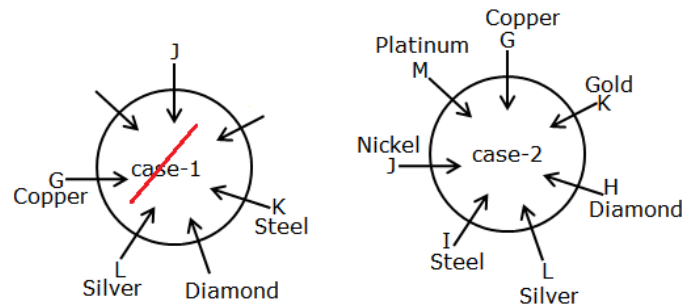

Directions (41-45):

- 41) Answer: A
- 42) Answer: E
- 43) Answer: B
- 44) Answer: C
- 45) Answer: E

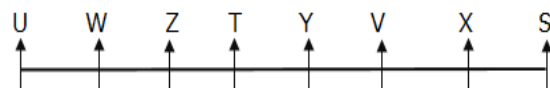

Top 50 Important Seating Arrangement Questions

- X stands second from one of the extreme ends of the row.
- T stands second to the left of V, who stands adjacent to X.
- The number of persons to the left of T is the same as to the right of Y.

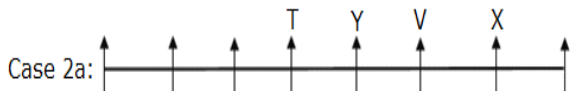
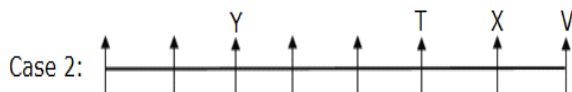
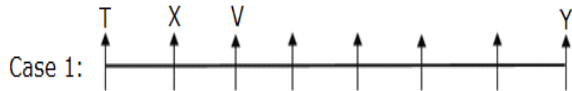

- More than two persons stand between Y and U (either on right or on left).
- S neither stands adjacent to U nor T.
- The number of persons between S and Z is one less than between W and S, who doesn't stand adjacent to Y.

Hence, cases 1 and 2 get eliminated.

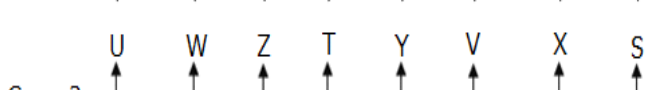
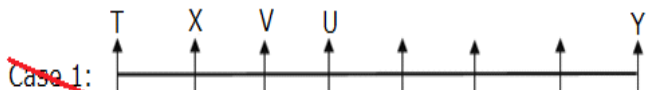

Direction (46-50):

46) Answer: C

47) Answer: D

48) Answer: D

49) Answer: A

50) Answer: C

Final arrangement:

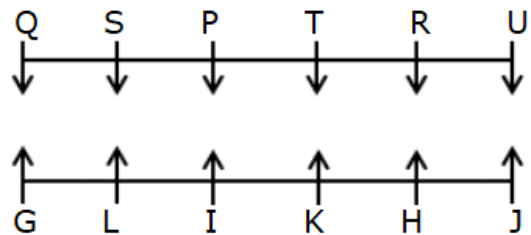

We

have,

- H sits four places away from the one who sits opposite to Q.
- K sits adjacent to H who doesn't sit at the extreme ends.
- K sits opposite to the one who sits second to the left of S.

From the above conditions, there are three possibilities

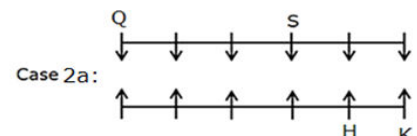
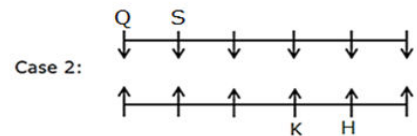
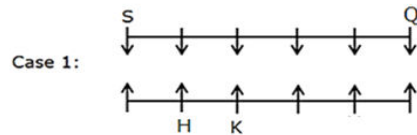

Again

we have,

- T sits opposite to the one who sits second to the left of J.
- J sits neither opposite to Q nor adjacent to K.

Top 50 Important Seating Arrangement Questions

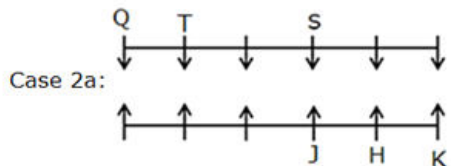
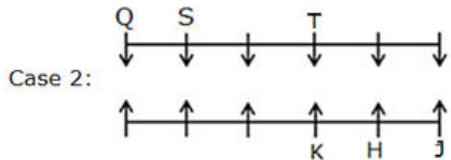
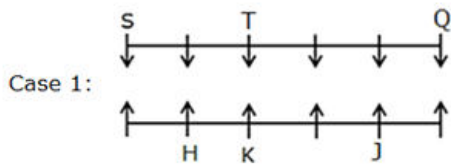

Again

we have,

- R sits to the immediate left of T.
- As many persons sit between T and R is same as between G and L who sits opposite to S. I does not sit at the extreme ends of the row.

So Case 1 and Case 2a get eliminated

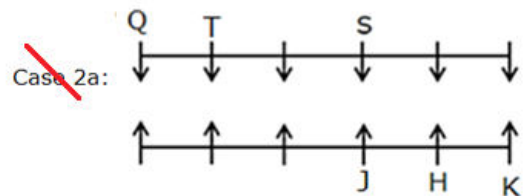
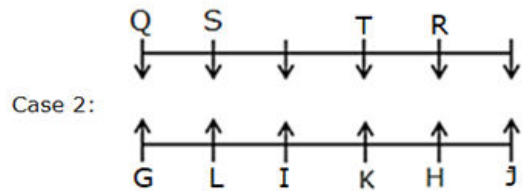
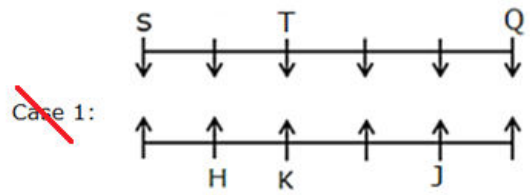

Aga

in we have,

- U sits towards the left of P.

Hence Case 2 shows the final arrangement

